

CURRENT TRANSFORMER

Model 144MR

Window Diameter 6.0"

Application:
Relaying

Frequency:
50 - 400 Hz

Insulation Level:
600 Volts, 10 kv BIL full wave



E228202

Continuous Thermal Current Rating Factor:
See TRF at curve.

- Terminals are brass screws No. 10 - 32 with one flatwasher, lockwasher and regular nut.
- The transformer winding is arranged so that the the turns are fully distributed between all taps.
- Order mounting bracket kit No. CR-CL separately.
- Approximate weight: 40 lbs

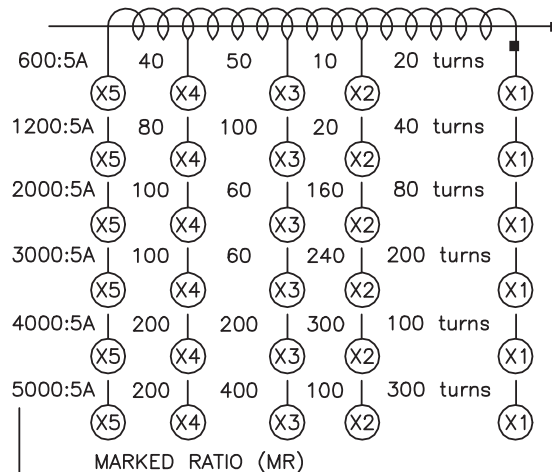
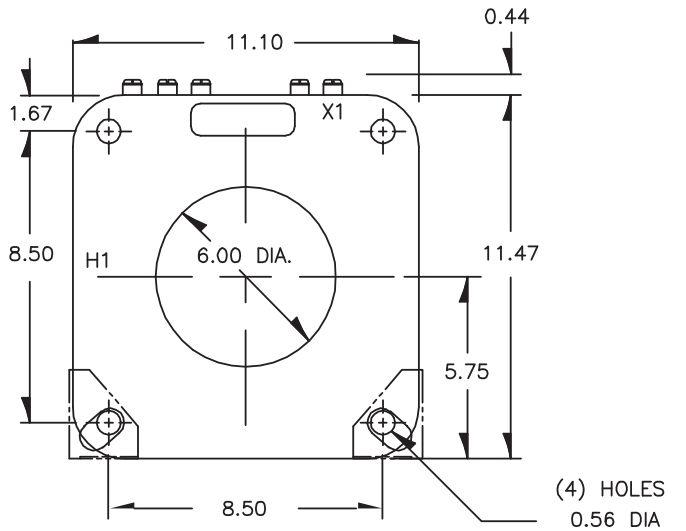
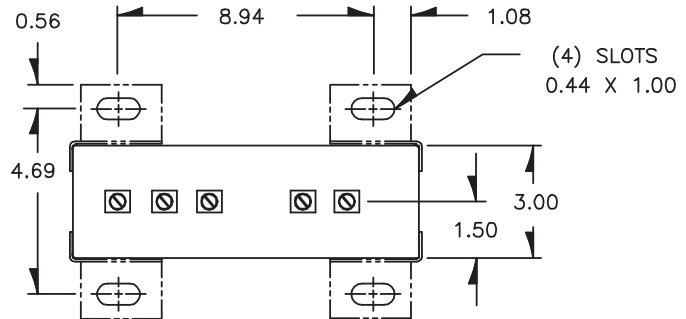
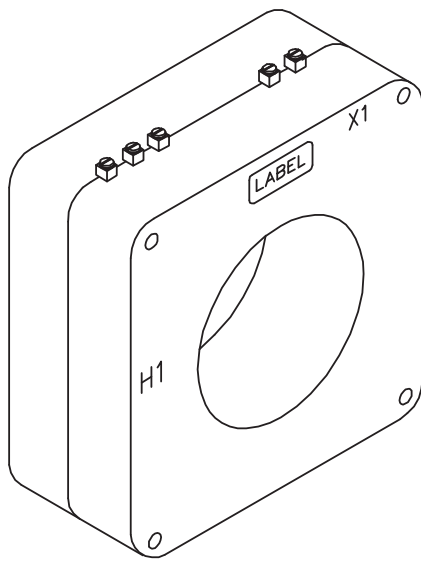

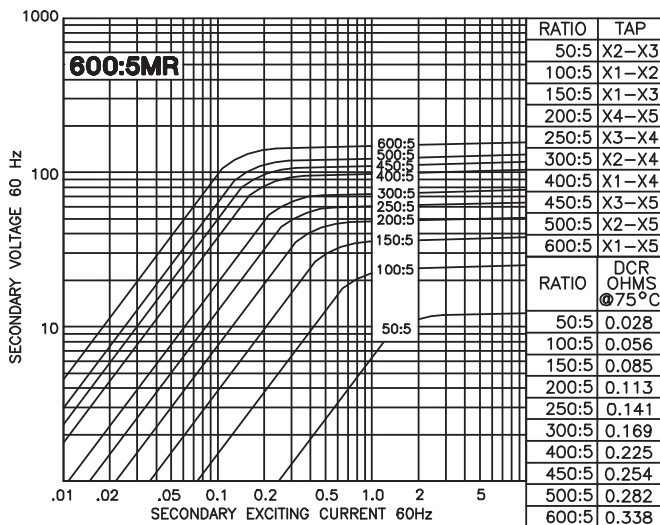

Model 144-601MR - rating C100
TRF= 2.0 @ 30°C, 1.5 @ 55°C amb.

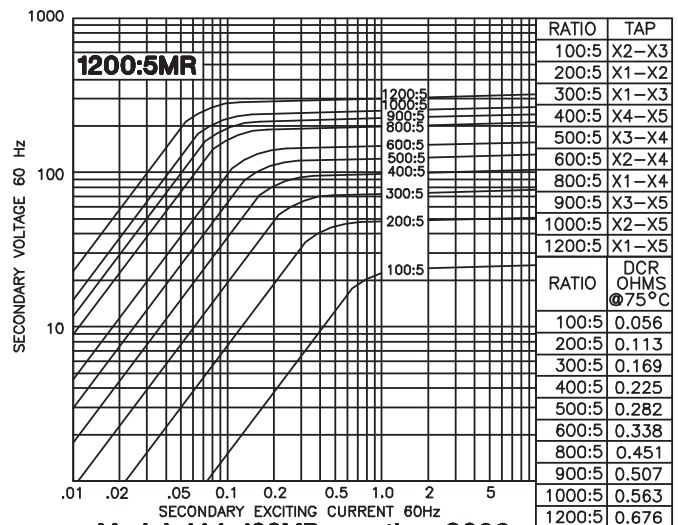

Model 144-122MR - rating C200
TRF= 2.0 @ 30°C, 1.5 @ 55°C amb.

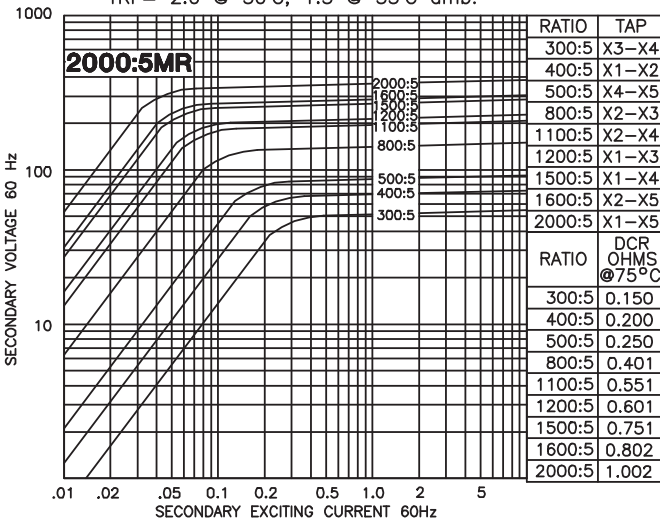

Model 144-202MR - rating C200
TRF= 1.5 @ 30°C, 1.0 @ 55°C amb.

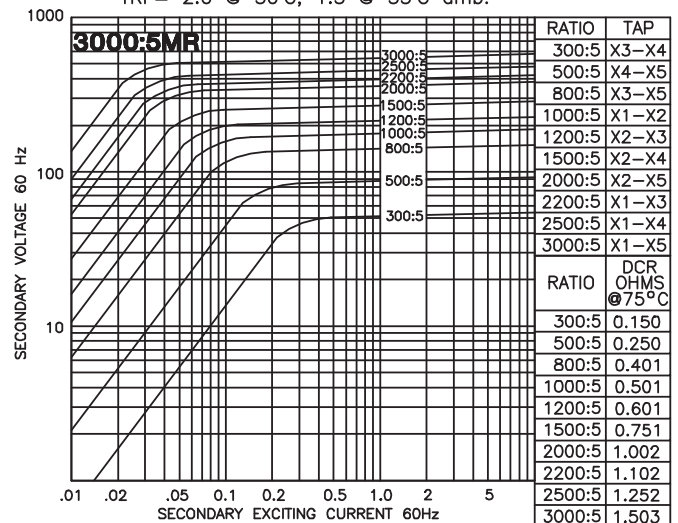

Model 144-302MR - rating C400
TRF= 1.0 @ 30°C, 0.8 @ 55°C amb.

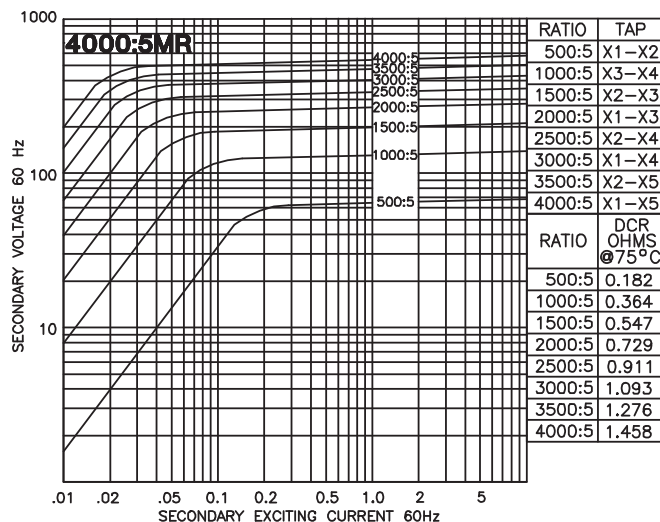

Model 144-402MR - rating C400
TRF= 1.0 @ 30°C, 0.8 @ 55°C amb.

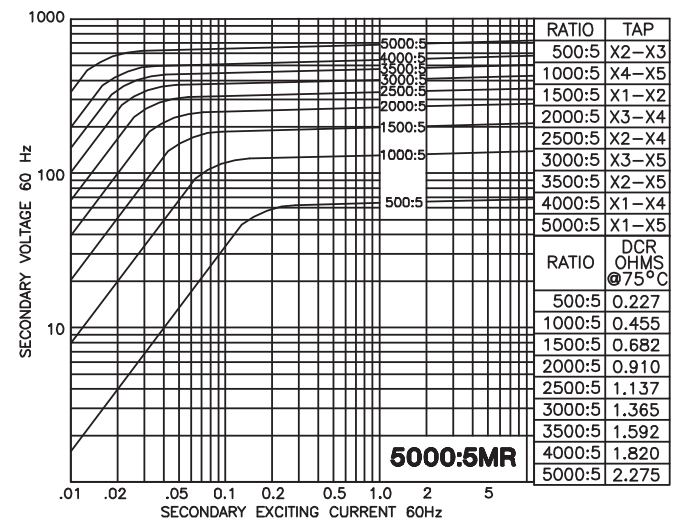

Model 144-502MR - rating C400
TRF= 1.0 @ 30°C, 0.6 @ 55°C amb.